

LED CEILING LIGHT USER GUIDE

Working Pattern (3 different patterns)

Microwave sensor

- In any given lighting condition, the light switches on automatically when presence detected.
- After presence left, light will continuously work within HOLD TIME, then switch off automatically.
- After presence left, any movement detected within HOLD TIME, the light will continuously work for another hold time, then switch off until next movement detected.
- Hold time: Please refer to "HOLD TIME" on product label.

Daylight & Microwave sensor

- With sufficient natural light, when illuminance is more than 10lux, the light does not switch on when presence detected.
- With insufficient natural light:
 - > When illuminance is less than 10lux, the light switches on automatically when presence detected.
 - > With presence detected, light will never switch off, even the nature light is sufficient.
 - > After presence left, any movement detected within HOLD TIME, the light will continuously work for another HOLD TIME, then switch off automatically until next movement detected.
- Hold time: Please refer to "HOLD TIME" on product label.
- ※ Optimum installation height: 3M

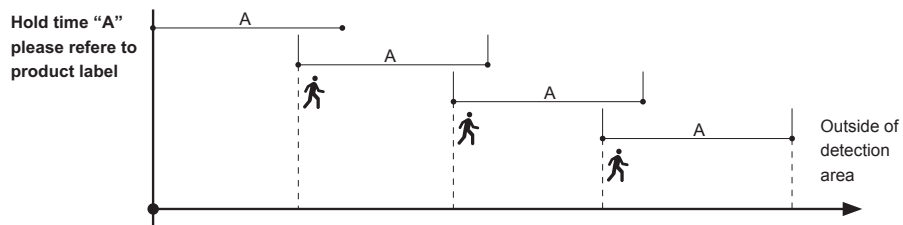

Color changeable (Controlled by Regular Switch) and dimmable

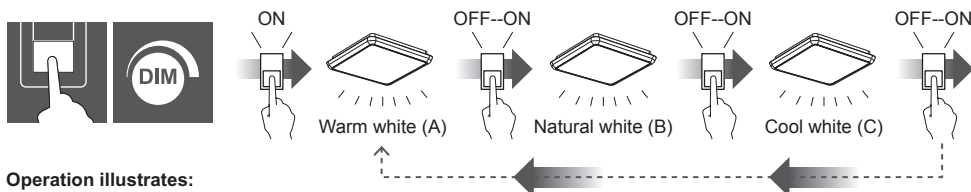

Operation illustrates:

1. First switch on with initial color A
2. Second switch on, change into color B
3. Third switch on, change into color C
4. Fourth switch on, step backward to color A
5. Triac dimmable is available once a color has been selected

// NOTE //

- The initial color can be customized upon request.
- When light is on, switch off within 0-2S, color changes from A~C.
- When light is on, continuously switch on and off for 4 times, restore to factory settings. Note: every single switch on and off is carried out within 2 seconds.
- When light is on, switch off after 2S, memory function is activated. Color remains the same for the next operation.

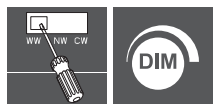

Color changeable (controlled by Slide Switch in lamp) and dimmable

Please select light color before mounting to ceiling or wall, see STEP 4.

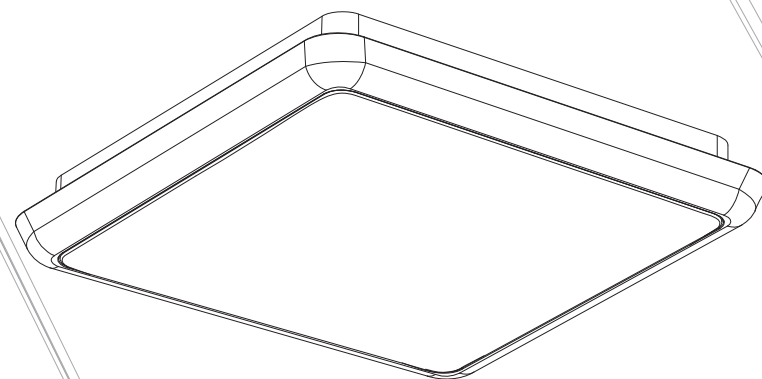

LED CEILING LIGHT USER GUIDE

SAFETY INSTRUCTIONS

To ensure correct function and safety, please read and follow all instructions carefully before using the product:

1. Turn off power supply before installation or before doing any maintenance work.
2. Do not install any luminaire near the heat source.
3. IP grade please refer to product label, only IP54 can be used in damp locations.
4. Do not exceed the nominal supply voltage or amperage ratings.
5. Dimmable version could be compatible with a wide range of recommended TRIAC dimmers.
6. All wiring and installation of the light fitting must adhere to local and national wiring rules.
7. Take care not to pull any electrical wires during unpacking as this may damage the connection.
8. Lay out all the components on a smooth surface and make sure there are no components missing before assembling.
9. To avoid injury or damage to the fitting, please ensure that power leads and screws are secure before connecting the power.
10. Please keep instructions for future reference.

For non replaceable light sources:

The light source of this luminaire is not replaceable; when the light source reaches its end of life the whole luminaire shall be replaced.

Installation Procedure

WARNING

1. Switch off before installation.
2. Switch on only after complete installation and examination of the circuit.
3. Professional electrician for installation and maintenance only.

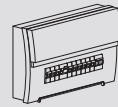

Turn Off power supply before starting any installation. Read instructions & check you have all the tools & accessories to complete the installation correctly.

Step 1

Take out the light and accessory pack from box.

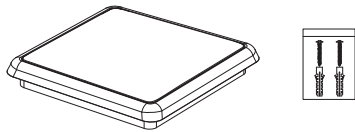

Step 2

Remove screw, take out bracket.

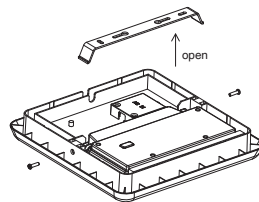

Step 3

(A) wiring diagram only for NON-emergency function light.

(B) wiring diagram only for Emergency function light.

Fix bracket with screws into the ceiling.

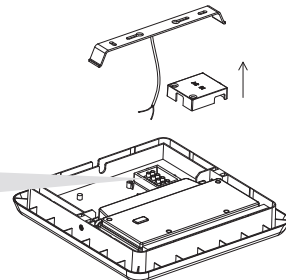
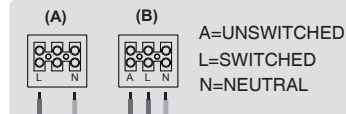

Step 4

For color changeable model (controlled by Slide Switch in lamp), please select light color before mounting to ceiling or wall, see below picture.

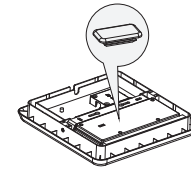

1. Take rubber stopper out from slide switch for color selection.

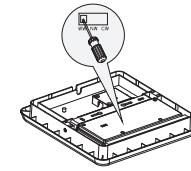

2. Choose color by slide switch with corresponding color temperature.

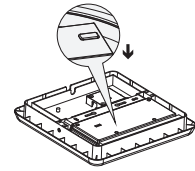

3. Insert rubber stopper back into slide switch properly.

Step 5

Mount ceiling light into the right place

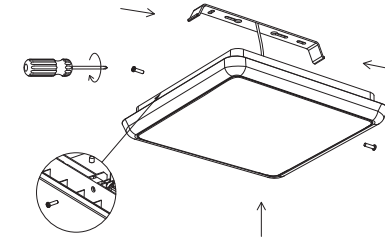

Step 6

Switch on

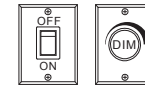
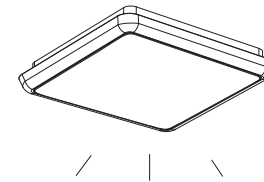

Functions Instruction (For specific function, please refer to actual model)



Emergency

Emergency function switches automatically between power cut and power restoration.

- Li battery, high efficiency
- Battery duration: 3 hours
- Charge period: 24 hours



Sensor

Detection area: 140 degree wide detective beam angle with 5-7 meters distance.

