

Rundit X

Inground light



Features

- Die casting aluminum housing
- Optimized heat dissipation structure
- Tempered clear glass with high efficiency of transmitting
- Stainless steel front cover ring
- Imported silicon rubber ring
- High intensity tempered glass



Recessed



IK Rating
IK10



IP Rating
IP67



Standard Warranty

TECHNICAL DATA SHEET - RUNDIT X 60 - 15245 - INGROUND LIGHT



TECHNICAL DATA

Product Data	Inground Light
Lamp Type	CREE LED
Wattage	60W
Color Temperature	3000K
Rated Luminaire Luminous Flux	6,600lm
Rated Luminaire Efficiency	110lm/W
IP Rating	67
Beam Angle	20°
Voltage	AC220-240V
Frequency Range	50-60 Hz
CRI	Ra>80
Power Factor	>0.9
Output Current	860mA
Safety Class	Class III
SDCM	<3
Operating Temperature	-20°C ~ +50°C
Load capacity	2000 Kilos
Material	Die Cast Aluminium + Stainless Steel
Finish	Stainless Steel
Life Span	50,000 Hours
Warranty	5 Years
Applications	Outdoors, Residential, Hospitality, etc.

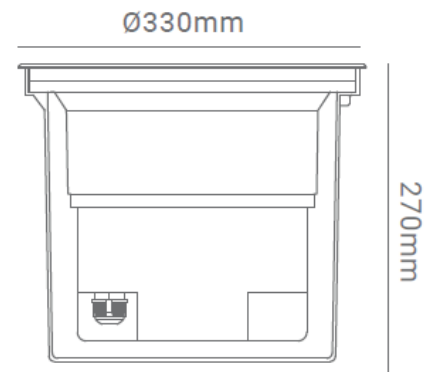
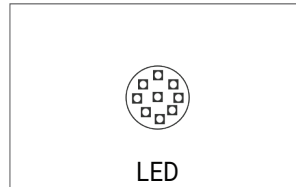

TECHNICAL OPTIONS

Wattage	6W/44W/60W
Color Temperature	3000K - 6000K
Beam Angle	8°/15°/24°/30°/45°/60°
Control	Switchable/TRIAC / DALI / 1-10V